

LTS-RN21060

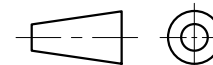

产品型号	LTS-RN21060
LED发光色	W(白)/R(红)
输入电压	DC 24V(max)
消耗功率	/
电缆极性	1:+、2:NC、3:-

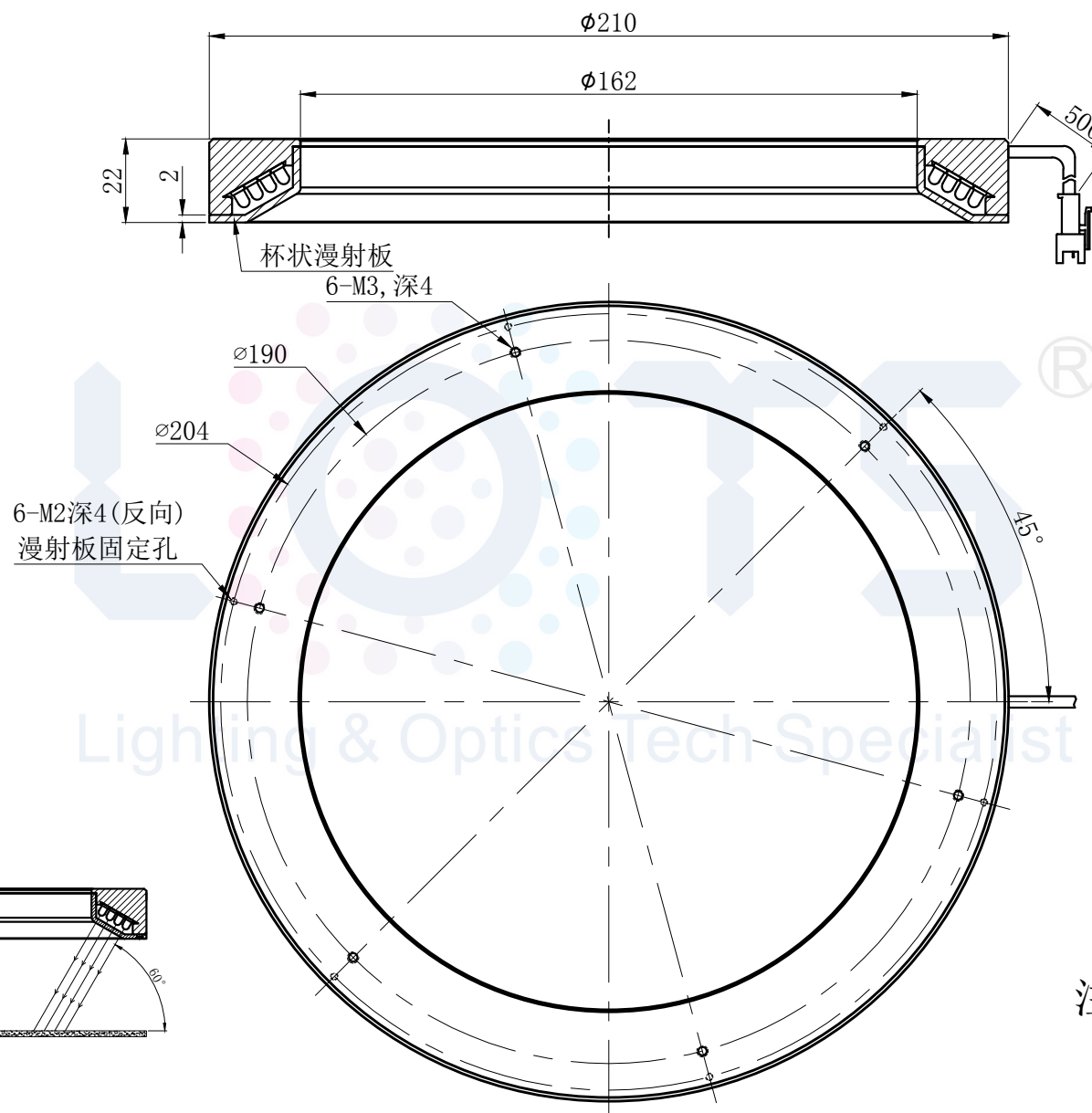

照明示意图

注：可选配杯状漫射板