

# LTS-RN2890

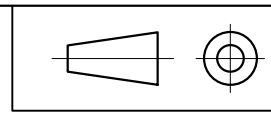

产品型号	LTS-RN2890
LED发光色	R(红)/W(白)
输入电压	DC 24V(max)
消耗功率	/
电缆极性	1:+、2:NC、3:-

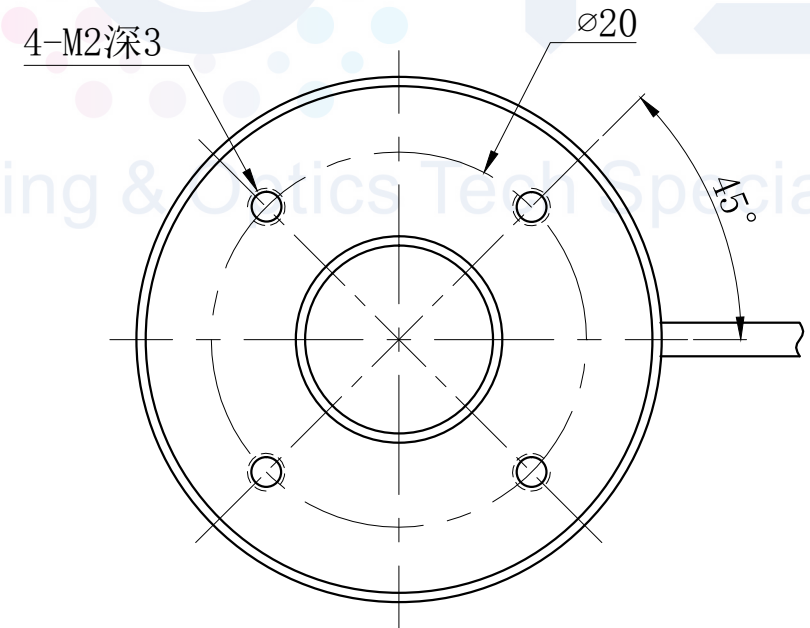
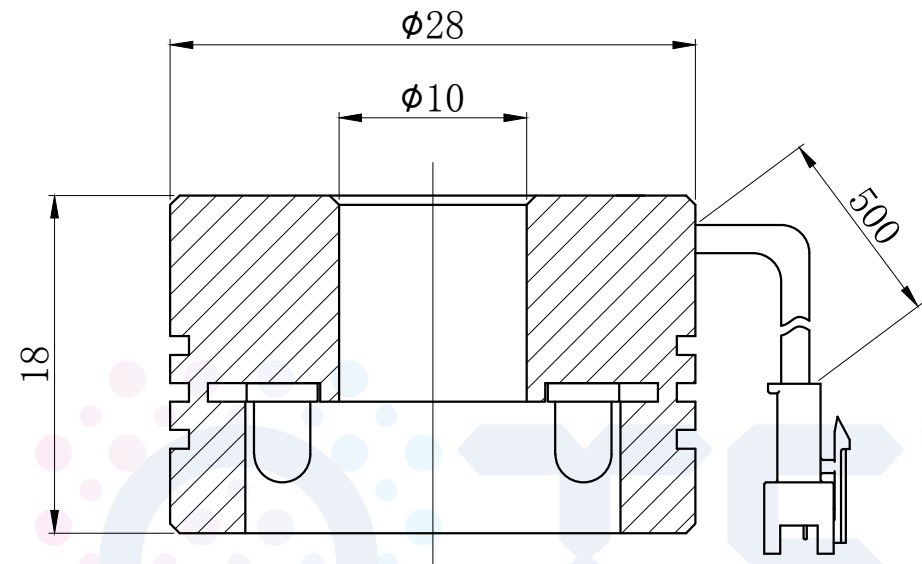

照明示意图

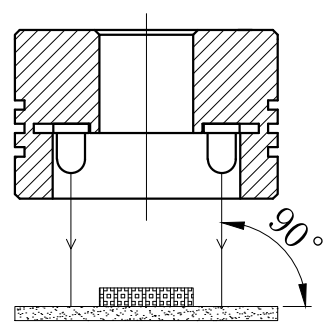

注：可选配平面漫射板