

LTS-3LINH1000

	产品型号	LTS-3LINH1000
	LED发光色	R(红)/W(白)
	输入电压	DC 48V(max)
	消耗功率	/
	电缆极性	1:LED+, 2:LED-, 3:FAN+, 4:FAN-

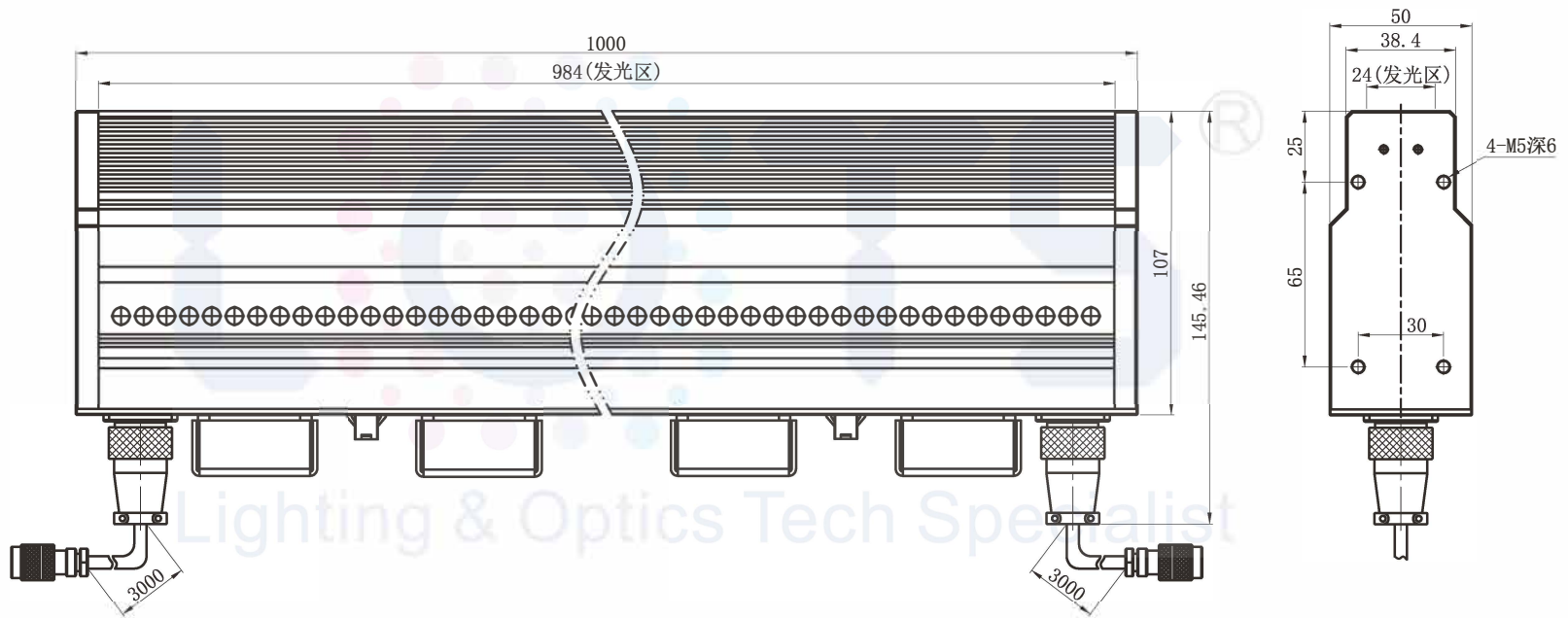

注: 两侧有M3和M5的螺母卡槽
用于安装。